

Equipment winding - unwinding

French Manufacturer of expandable airshafts - Safety chucks - Brakes - Spreader rolls

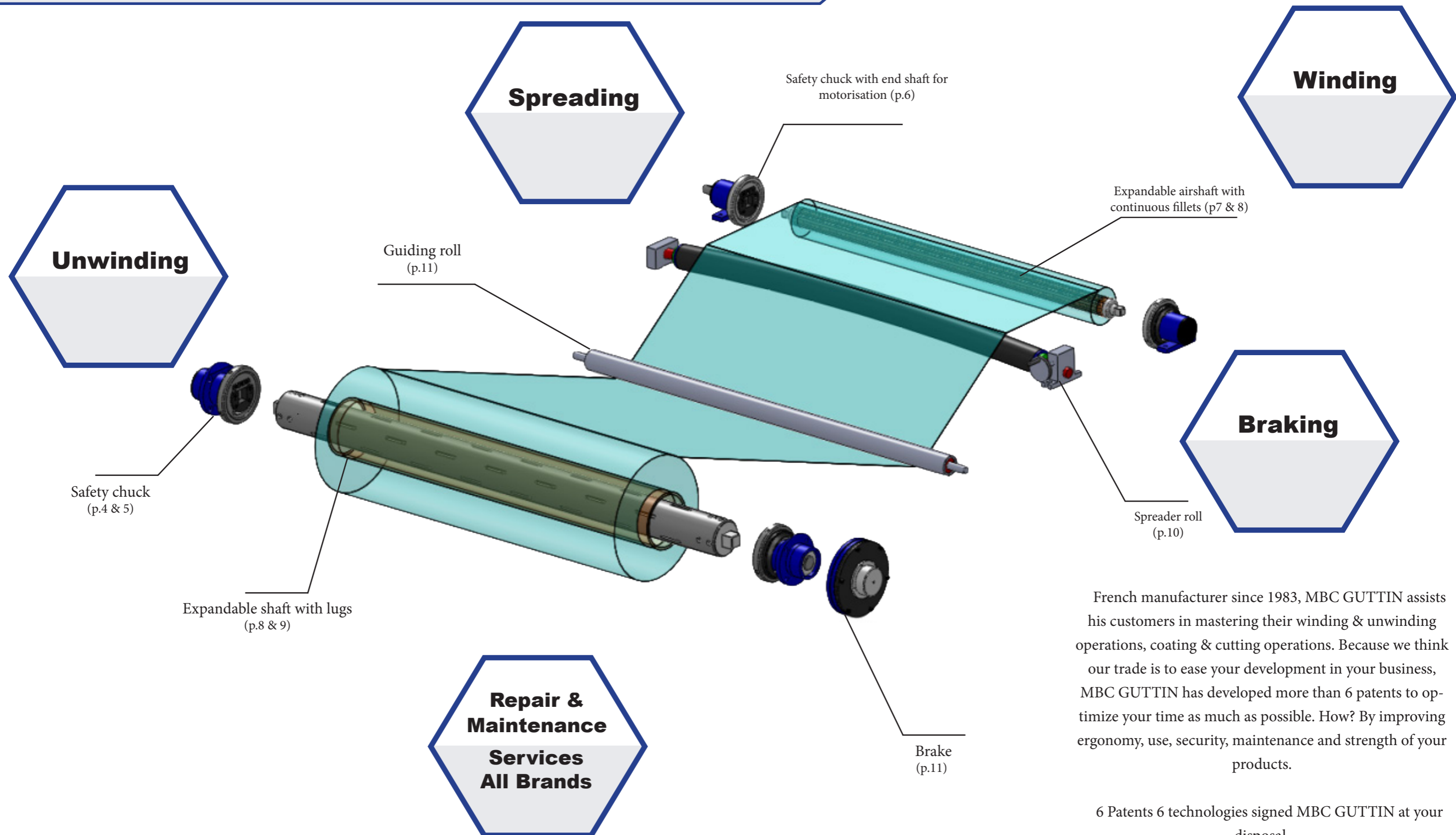

MECHANISM
BLOCKING
CONTROL



French manufacturer since 1983, MBC GUTTIN assists his customers in mastering their winding & unwinding operations, coating & cutting operations. Because we think our trade is to ease your development in your business, MBC GUTTIN has developed more than 6 patents to optimize your time as much as possible. How? By improving ergonomoy, use, security, maintenance and strength of your products.

6 Patents 6 technologies signed MBC GUTTIN at your disposal.

Benefits

Made in France

100 % steel

To be mounted instead any installation :
replacement – custom made - repair

Possibility of certain adaptation according to
your requests

Safety

Auto- Lock system

Garantee more security

A chuck with several options for your safety
& different types of locking system (p6)



The MBC safety chucks (Mechanism Blocking Control) were designed to achieve all your winding & unwinding operations. Its automatic locking system protects in the event of an accident. Discover all our designs and find the solution that best suits your needs.

Patents MBC



Easier maintenance

A chuck design to optimize your maintenance time.

Gain nearly 15 minutes on the change of your wear parts.

7 screws and a disassembly only by the front face !

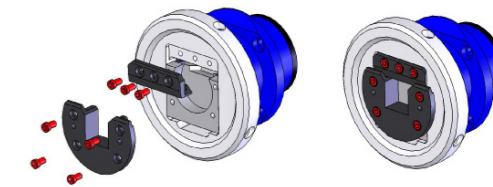

Easier maintenance

Disassembly of steering wheel axis and the locking ball becomes simply as child's play.

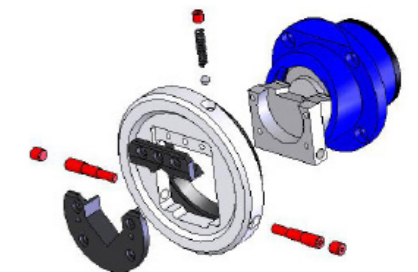

Design

Design of the locking system made with a push button stronger, more secure, more ergonomic.

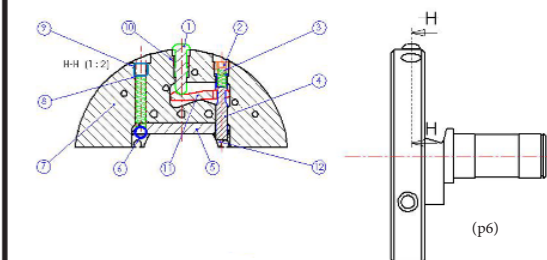

MODEL	REEL WEIGHT	TORQUE	SQUARE DIMENSION
14 – 20	150 kg	40 Nm	14 to 20 mm
18 – 25	400 kg	120 Nm	18 25 mm
20 – 30	800 kg	185 Nm	20 to 30 mm
30 – 40	1600 kg	350 Nm	30 to 40 mm
40 – 50	2850 kg	1 100 Nm	40 to 50 mm
50 – 80	7200 kg	2 350 Nm	50 to 80 mm
80 – 120	11 500 kg	9 000 Nm	80 to 120 mm
120 – 180	22 000 kg	20 000 Nm	120 to 180 mm
180 – 230	60 000 kg	40 000 Nm	180 to 230 mm

Available goods

Manual chuck

- Chuck with pivoting disc
- Chuck with slidding disc
- Translatory chuck, stroke 50 or 100 mm

Pneumatical chuck

- Pneumatical chuck simple or double effects
- Pneumatical selcentring and multifunctions

Choice of options :

Choose your fixation type :

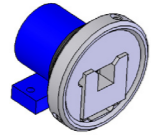
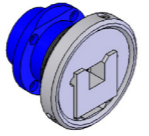
Foot (serie 150)   Flange (serie 250)

Choose your shaft end (coupled to a motorisation or a braking system) :

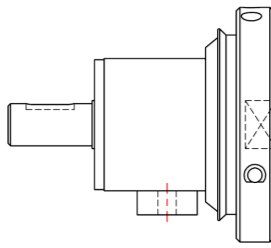
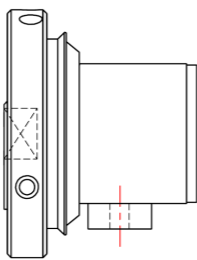

Chuck with shaft end = SFE/G   Chuck without shaft end = SFE

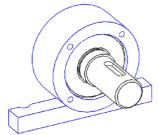
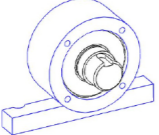
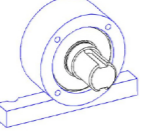
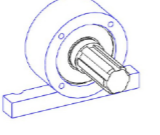
If with shaft end, choose the type best suited for your application :

STD  MD  BD  AC  Other applications on demand

Choose your geometry :

WITHOUT wear part

Type A  Type E  Type B 

WITH wear parts

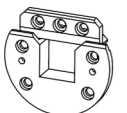
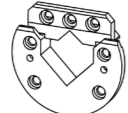
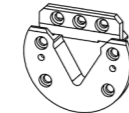
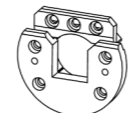
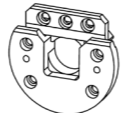
Type APU  Type EPU  Type BPU  Type AVPU  Type AWPU 

Choose your anti opening system :

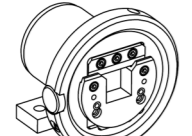
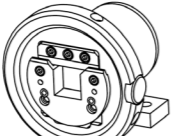
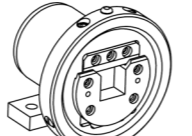
Type 1 - Left knurl  Type 1 - Right knurl  Type 2 - Push button 

Patent MBC : Chuck serie 2000

Benefits

- Work at high speed
- No vibration
- Selfcentring
- Multifunction
- Axial adjustment

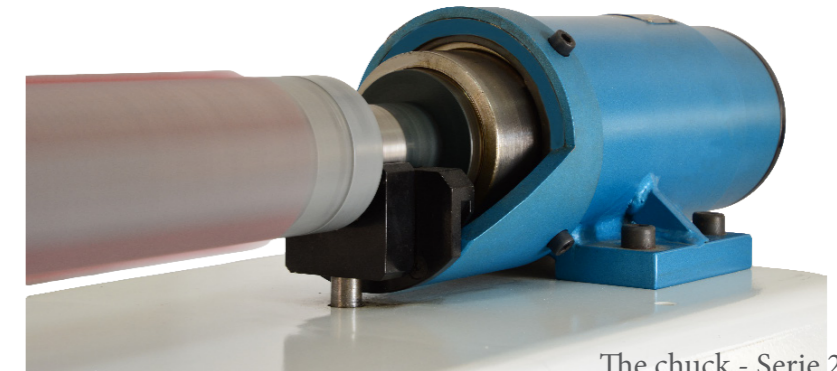

The chuck - Serie 2000 & 2100 is a pneumatical chuck that simplify your operation and improve your performance.

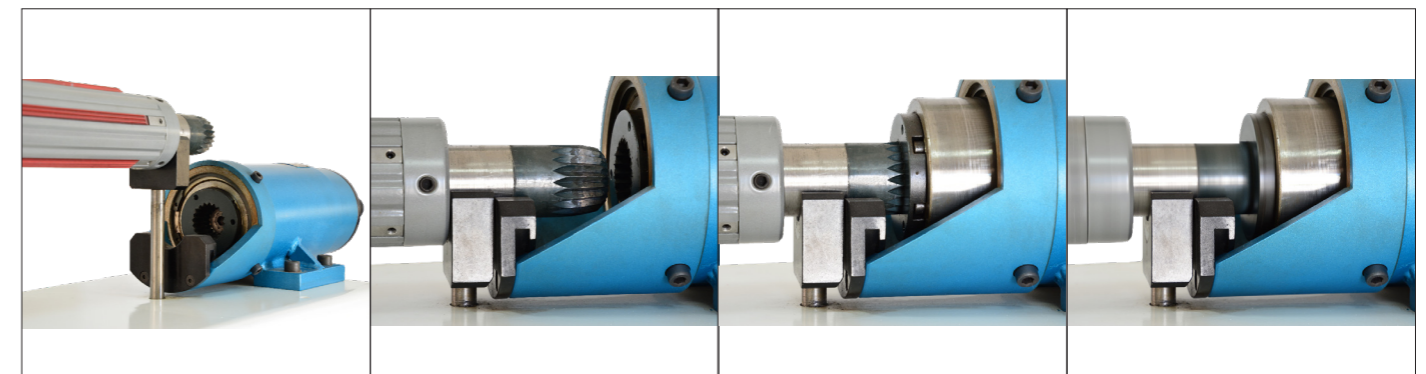

Step 1

Install your shaft on the support

Step 2

Start your pneumatical system

Step 3

Thanks to his conical tip, the Serie 2000 collects and center automatically the shaft. The double conical tip avoids damaging effects on the notched end.

Step 4

Start rotation. You have now a rotation with no vibration which allows the work at very high speed, in safer conditions, with better performances.

Options available:

Smooth shaft support



Expansible head with shells



Shaft support with journal bearing



Expansible head with lugs



Benefits



Made in France
since 1983

Engineering Department
Custom made - Repairs

Lightness : MBC Guttin
thinks about your users !



R&D of a reinforced aluminium :
+ 35 % load
- 40% bending
for an equal weight to a standard
aluminium shaft

Choose your material :
Aluminium - Steel,
and only for shaft with lugs :
Carbon - reinforced Aluminium

Choose your expansion :
Rubber - Aluminium - Steel

Choose your expansion :
With lugs or continuous fillets

Choose your shaft end :
Square - triangle - double
geometry or custom made.



Expandable airshafts allows the inside core
to mold the shaft and to exert winding &
unwinding operations.

Manufacturer, MBC offers expandable
airshafts from $\varnothing 1''$ (25.4 mm) up to
 $\varnothing 35''$ (900 mm) and up to 9 m length.

We carry out the desire shaft end with all
your specifications needed for your
application.

Patent MBC

Airshaft with lugs

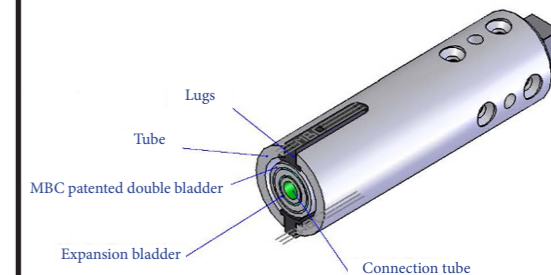

Strengthness

Protection of the bladder kit with the
«double skin».
Unique & patented by MBC Guttin.



Easier maintenance

Thanks to our double skin bladder, the
lugs remain in place !
You save 45 minutes when changing the
bladder kit.

Design

Airshaft with continuous fillets

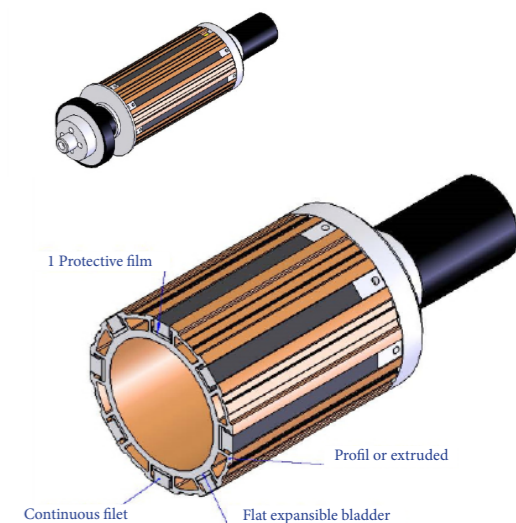

Expandible head



- Cantilevered work
- Rigidity & adaptability
- Stationary bar

Sleeve



- Quick use
- Change of \varnothing if desired
- Easily switch from $\varnothing 74$ mm to $\varnothing 150$ mm

Airshaft with shells

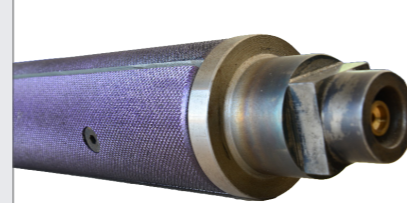

- Protects the final product
- Thin thickness cores
- Use without cores

Design for paper industry

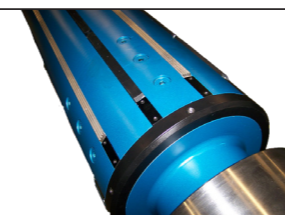

- Locking & centring continuous filets
- Static balancing of the tube
- 1750 m/ min - up to 15 tons

Friction bar

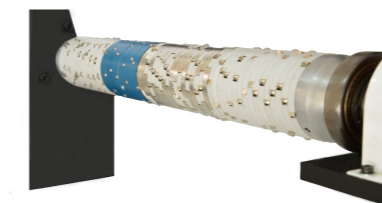

- Multitracks
- Friction rings (balls or pawls)
- Equal tension on each spool

SPREADER ROLLS

Get the best spreading system for your material.

A good spreading is obtained by the choice of an advisable material adapted to your product as well as the type of fold. MBC provides 4 kinds of spreader rolls, all specific to each application.

Curved spreader roll or Banana roll

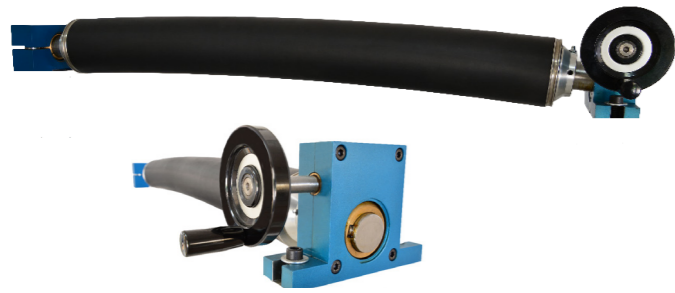

Spreader roll with stainless steel laths



Benefits

- Operates by deformation
- The most polyvalent of our spreader rolls (moisture, corrosive..)
- Different kind of coating or fully made of stainless steel
- Fixed or variable curvature

Benefits

- Operates by spreading
- Suitable for heavy and delicate materials
- Different kind of coating for the laths

Spreader rolls with ropes



Spiral spreader rolls (machinated or add-on)

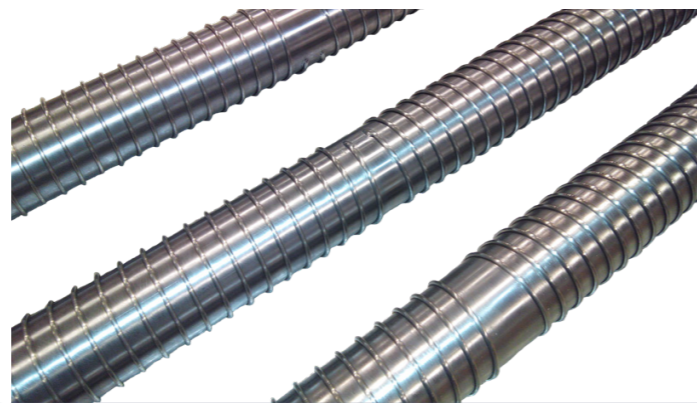

Benefits

- Operates by spreading
- Perfect for technical textiles & delicate materials
- Polyvalent (film, plastic...)
- Different kind of ropes

Benefits

- Operates by spreading the material effortless
- To be mounted instead of guiding rolls
- Thickness & depth choices
- Available in aluminium, steel, stainless steel, rubber
- No maintenance

BRAKES

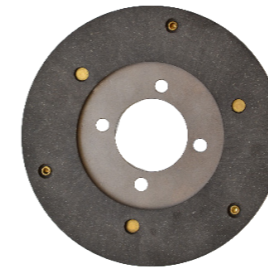

Manage the tension of your product thanks to our MBC braking system. At MBC we offer a ferodo brake, manual or pneumatical, made in France, fitting all your applications.

Even more accuracy? We also have multi-piston and electrical brakes. Do not hesitate to contact us !

Power	∅A	L
40 Nm	145	100
70 Nm	220	100
480 Nm	300	100

Power	∅A	L
90 Nm	145	125
180 Nm	220	125
900 Nm	300	125

Power	∅A	L
40 Nm	145	125
70 Nm	220	125
480 Nm	300	125

Power	∅A	L
90 Nm	145	145
180 Nm	220	145
900 Nm	300	145

MANUAL BRAKE

MBC Guttin

PNEUMATICAL BRAKE

MBC Guttin

Miscellaneous

- Anti-static Material
- Tension Control

Guiding roll



Support base axial and or radial adjustment for chuck

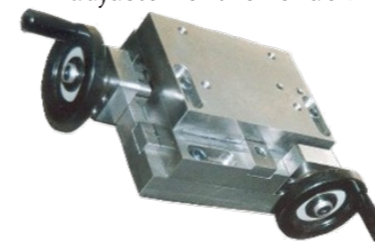

Mechanical head expansion with torque



Trolley and/or frame design



Mechano pneumatical or manual reel riser



Mechanical head with axial thrust

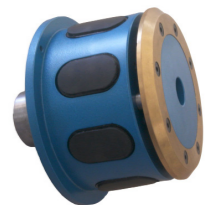

Shaft with bearing case for cantilevered unloading



Fiberglass Core

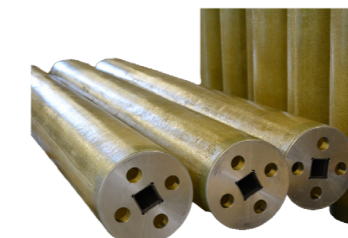

Aluminium locking cones











GLOBAL PRESENCE



50 Route du Charmay - 38490 CHARANCIEU
 Tél : + 33 (0) 4 76 32 07 82 - Fax : + 33 (0) 4 76 32 29 56
 www.guttin.com - mbc@guttin.com

Management Fabrice & Stéphane GUTTIN	Sales Patrick CREUSET + 33 (0) 6 61 30 07 83	Administrative & Accounting Stéphane GUTTIN Marie -Blanche GUTTIN	Technical Manager Fabrice GUTTIN
Insides Sales France Isabelle LECUYER	Export Marion MORONVALLE		Engineering - Custom Service Julien GULLON
Company Founder & Consultant Christian GUTTIN			Quality & Production Manager Gérard REYNAUD

— Our Worldwide Sales —

 SWITZERLAND CORTECH AG Mr Sandro CORTESI (tel) 0041 62 752 20 84 (fax) 0041 62 752 23 69 info@cortechag.ch	 NETHERLANDS OPENSUPPLY B.V. Mr Erik FRANKE (tel) 0031 541 700 260 (fax) 0031 541 744 025 erik@opensupply.eu	 USA LOUIS P. BATSON Incorporated Mr Chuck WITHINGTON (tel) 001 864 242 5262 (fax) 001 864 271 4535 chuckw@lpbatson.com	 POLAND ANT MASCHINENHANDEL UG Mr Alex NITUSOV BERLIN (tel) 0049 30 985 984 26 0049 173 272 69 00 info@ant-germany.com	 CZECH REPUBLIC ANT MASCHINENHANDEL UG Mr Alex NITUSOV BERLIN (tel) 0049 30 985 984 26 0049 173 272 69 00 info@ant-germany.com
 NORTH GERMANY ANT MASCHINENHANDEL UG Mr Alex NITUSOV BERLIN (tel) 0049 30 985 984 26 0049 173 272 69 00 info@ant-germany.com	 SOUTH GERMANY Mr Juan Jose SANCHEZ KARLSRUHE (tel) 0049 176 87 74 38 jsanchez@guttin.com	 SPAIN BARBANY Maquinaria Textil Mr Rodolf BARBANY (tel) 0034 93 450 16 87 (fax) 0034 93 347 84 54 info@barbany.com	 AUSTRIA HENNLICH Gmbh & Co KG Mr Andreas HOCHHOLD (tel) 0043 7712 3163 0 (fax) 0043 7712 3163 24 andreas.hochhold@hennlich.at	